



Guide to Installing your AmeriGlide Stair Lift

WELCOME TO THE AMERIGLIDE FAMILY

Congratulations on your stair lift.

These instructions will assist you in making sure your installation is safe and successful. Please read through them completely prior to attempting to install the unit.

TABLE OF CONTENTS

Page 2	Welcome to Our Family	Page 10	Installing plastic chain & traveling power cable;
Page 3	Before you start	Page 11	Installing the power cord
Page 4	Required tools; Receipt of unit	Page 12	Installing the seat
Page 5	Installing the lower tracks	Page 14	Installing the upper limit cam; Installing the call controls
Page 7	Checking the track	Page 15	Completing track installation; Final checks; Additional notes
Page 8	Routing the lower call control wire; Installing the unit		
Page 9	Slack cable reset procedure		

BEFORE YOU START

Pre-Installation Checklist

- Is there any visible damage to the packaging? If so, immediately contact the freight carrier and report the damage.
- The side of the stairs on which the unit and track will be installed are marked on the chassis and seat boxes. Verify that you have received the correct hand unit (as looking up from the bottom of the stairs).
- Is a properly grounded 110-volt, 15amp (standard outlet), available within 10' of the top of the track?
- Have you "pulled" the necessary permits in your area for installation?
- Are your stairs made of wood? If not, special mounting hardware will be required. Contact your dealer for assistance.
- The track will extend 6" beyond the top step. Is there a door or other obstruction at the top that will interfere? If so, contact your dealer for assistance.
- If after reading the instructions, you don't feel capable or comfortable with completing the stair lift installation, please contact your dealer for assistance in finding a qualified installer in your area.

ETL REQUIREMENTS

This ETL listed stair lift must meet the latest ASME A18.1 standards for the ETL listing to be valid.

The following clauses must be complied to at the installation site.

ASME Clause 4.1.1*

Lifts shall be installed so that means of egress is maintained as required by the authority having jurisdiction.

ASME Clause 4.1.2*

The structure on which the equipment is installed shall be capable of safely supporting the loads imposed.

ASME Clause 4.7.2

Limitation of Angle. No lift shall be installed to operate on a greater incline than 45 deg as measured on the mean.

* Applicable to stair lifts installed in locations other than in or at a private residence.

R E Q U I R E D T O O L S

You will need the following tools to complete the installation:

- 5/32 allen wrench
- 3/8, 7/16 & 9/16 open-end wrench
- phillips screwdriver
- 3/8 socket on 8" extension in an electric or cordless drill

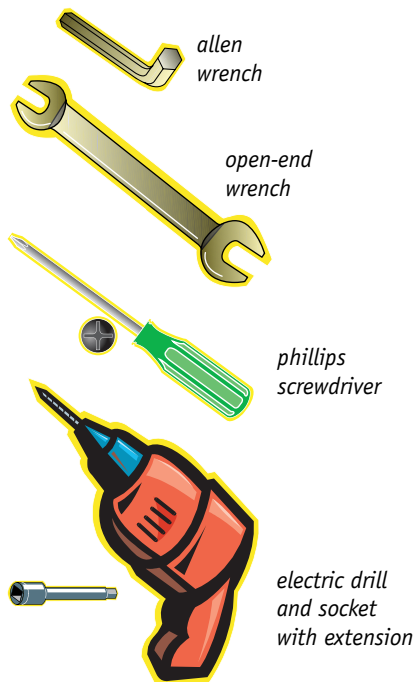
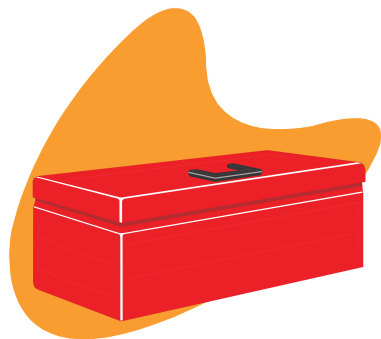

R E C E I P T O F U N I T

- Your stairway lift will arrive in three boxes.

These will consist of:

- seat box – 38 lbs
- unit and top 2' track – 115 lbs.
- track box – 40-80 lbs (depending on track length)

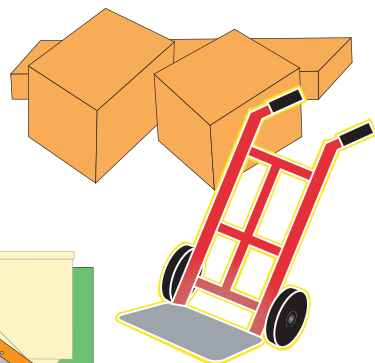

- Check each box for any possible shipping damage.

CAUTION: Use a dolly or get assistance in carrying the chassis box to avoid injury.

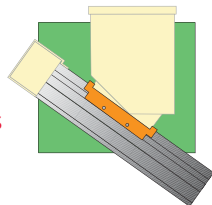

NOTE: The chassis is shipped attached to the top 2' of track.

I N S T A L L I N G T H E L O W E R T R A C K S

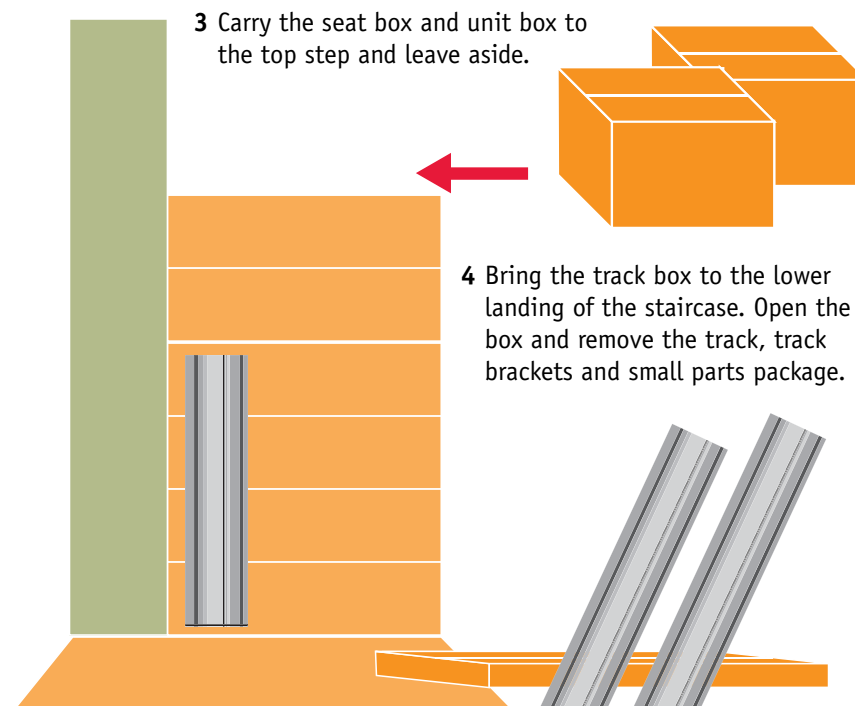

- In the small parts package you will find:

- track bracket bolts
- wood screws
- 2 self-drilling screws
- call control extension cord and bracket

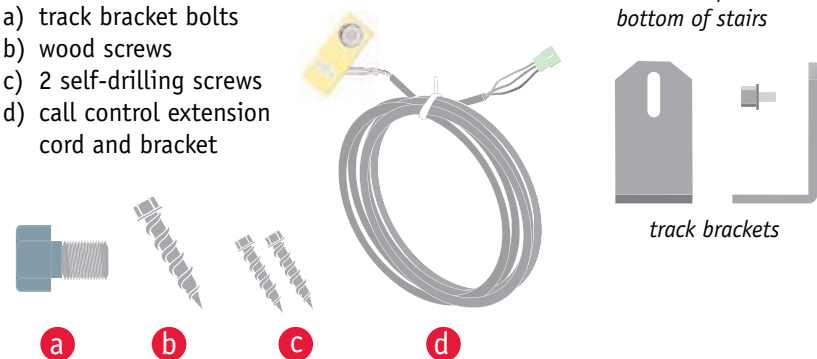

- Identify the bottom track section. It will have a *metal end plate* at one end. Lay the lower track section on the steps as shown in the picture above.

NOTE: Top track section will be installed with the unit after installation of bottom and mid tracks. It requires 2 brackets.

INSTALLING THE LOWER TRACKS

- 7 Use the track bracket bolts to fasten brackets to nuts in the track channel.

Position track brackets as follows:

- 1 bracket pair on bottom step
- 1 bracket pair on top step
- 1 bracket pair above and below where the tracks splice together

Hand tighten the bolts only - the brackets will need to slide for correct positioning.

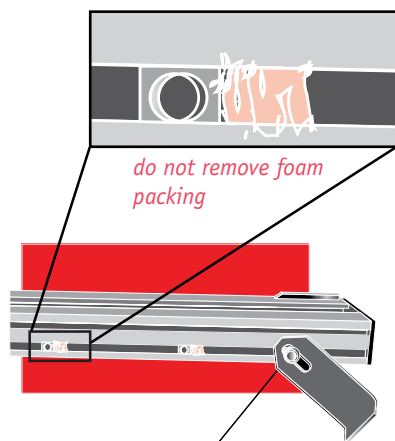

NOTE: attach a bracket on the bottom nut, but leave the nut second from the bottom unused - it will be used later.

- 8 Splice bars are used to join the track sections together. Locate the splice bars and loosen the set screws from their shipping position. Slide the splice bars to half way and tighten the two set screws remaining in the track to hold them in place. *The tracks will not slide together if the set screws protrude beyond the splice bar.*

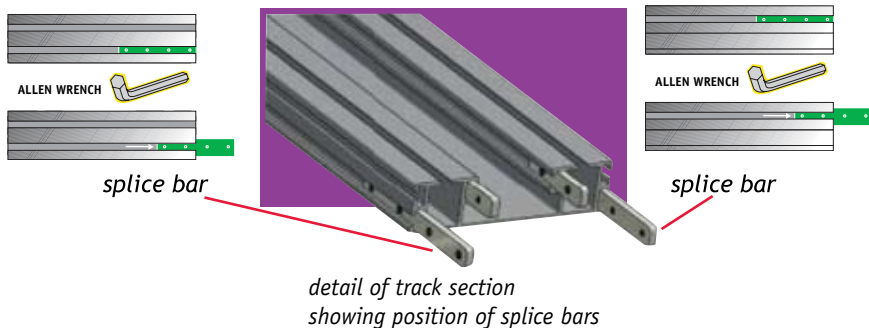

- 9 Slide the upper track section onto the lower track section. Tighten the splice bar set screws to lock tracks together.

CAUTION: Do not put your fingers between the track sections at any time as injury could occur.

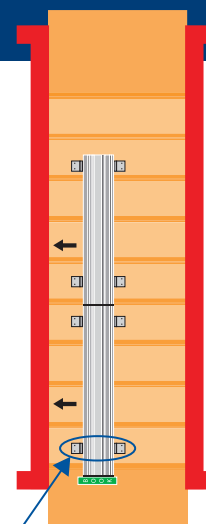

- 10 Slide the track and brackets against the wall or molding. This will position the track the required 2" from the wall. If there is an obstruction on the wall; ex: handrail, window sill, etc; the track will need to be positioned 2" out further than the obstruction. Temporarily set something under the bottom of the track to raise it 1/2" - 3/4" off the bottom landing. *This will prevent the track from hitting the floor later when the track brackets are tightened.*

- 11 With bracket resting on step, position track bolt in upper half of track bracket slot.

Only secure the bottom brackets

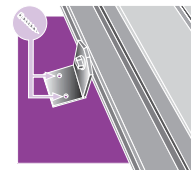

- 12 Starting with the bottom step, screw the bracket half-way down - remove book - and finish securely attaching bracket to the step.
- 13 Securely tighten remaining track brackets to the steps using provided wood screws.

- 1 Track is designed to lay directly on the step noses, or it can be supported completely by the track brackets.

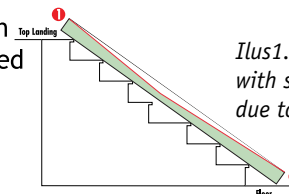

Ilus1. - Track shown with sagging area due to "short" step

- 2 Pull a piece of string taut from the top of the track to the bottom. Mark any places where the string is not parallel with the track. Check the results by using the string again. Track and string should now be parallel.

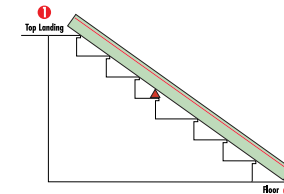

The wall-side of the track may be pulled down further than the stair-side of the track on steps with thick carpeting/pad. **Final track adjustment should occur after the unit is installed.**

The track should still move vertically in the bracket slots for final adjustment.

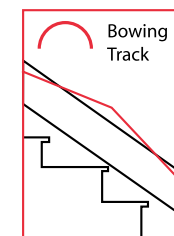
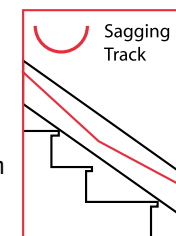

ROUTING THE LOWER CALL CONTROL WIRE

- 1 On the wall-side of the track, attach call control bracket to the second nut up from the bottom just above the bottom track bracket.
- 2 Route the wire through the top track channel on the wall-side of the track.
- 3 At the top of the middle section of track, tuck the wire underneath the track out of the way.
- 4 You will finish routing the call control wire after the top track section is in place.

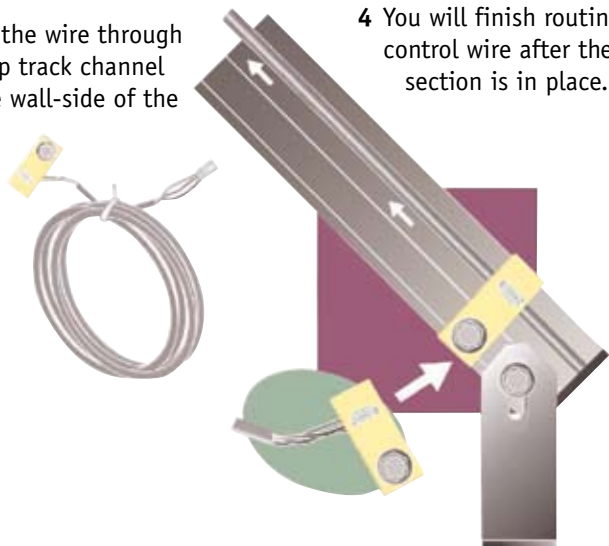

INSTALLING THE UNIT

CAUTION: Assistance may be needed for this part of the installation due to unit's and upper track section's weight.

- 1 Open unit box by cutting down the sides of the box. Fold the sides of the box down and slide the unit and top track to the edge of the steps.
- 2 Remove cardboard packing from back of footrest.
- 3 Remove the shipping brace from the upper section of track and set aside.

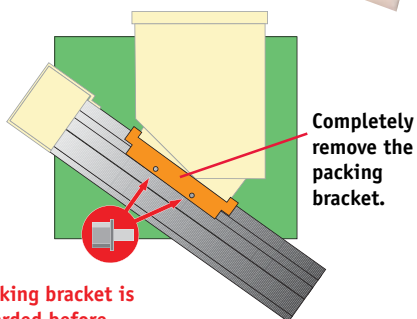

Make sure the packing bracket is removed and discarded before attempting to operate the lift.



- 4 Loosen the splice bars from their shipping position and slide them out to half way. Tighten the splice bars.

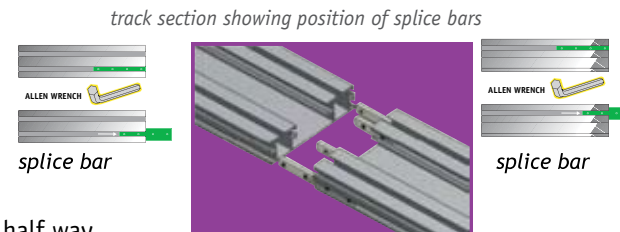

- 5 Slide the upper track section onto the lower track section. Tighten the splice bar set screws to lock tracks together. *The tracks will not slide together if the set screws protrude beyond the splice bar.*
- 6 Attach track brackets to the side of the top track section. Hand tighten.

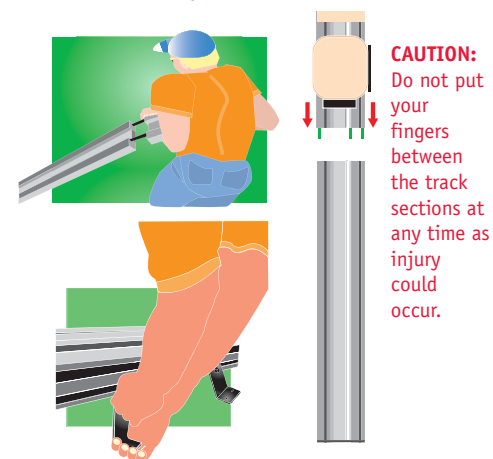

SLACK CABLE RESET PROCEDURE

- 1 During shipping, the slack cable device may engage and need to be reset.

The slack cable safety prevents the lift from running when there is not enough tension on the cable.

- 2 With the unit and upper track section installed and power cable unplugged, you will use the hand crank to turn the motor belt that turns the cable drum.

The illustrations show overhead and cut-away views of the unit.



SLACK CABLE RESET PROCEDURE

- Place the manual hand crank onto the motor shaft and rotate clockwise. This will slowly inch the unit up the track.

If you see the lift begin to move uphill or hear a click, that will tell you that the slack cable has reset.



INSTALLING PLASTIC CHAIN AND TRAVELING POWER CABLE

- Lay cable and chain in track. It will extend a little more than half way down the track.
- Take one side of the traveling cable and tuck into the bottom channel in the middle of the track.
NOTE: The power cable will face in toward the metal channel.

- Feed the other side of the cable into the channel on the opposite side.

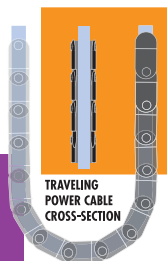
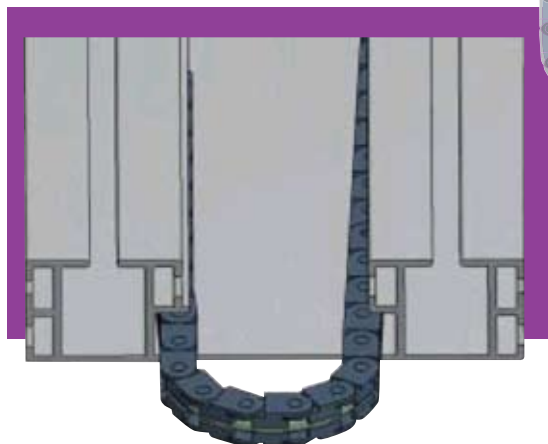

Note: Check every chain link. If unsnapped, the chain will not bend correctly.

INSTALLING PLASTIC CHAIN AND TRAVELING POWER CABLE

- After laying the trailing cable and guide chain into the track channel, pull down on the cable to make sure there is no slack and it is straight under the left channel tight against the side
- While holding the cable tight in place, use a $\frac{1}{4}$ " driver to run the self drilling screw into the track utilizing one of the two holes in the guide chain mounting bracket. Two holes are provided in the mounting bracket in the event that one of the holes would happen to be directly over a splice between two pieces of track.



INSTALLING THE POWER CORD

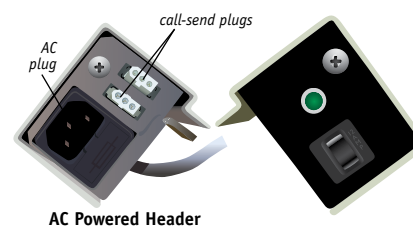

1 For AC Powered Lifts

Locate the power cable and plug into the side of the upper track cover. The green light should light up - indicating the unit is receiving power. If not, check the circuit breaker under the green light.

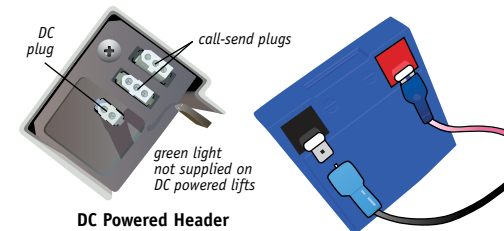

2 For DC Powered Lifts

The batteries need to be connected prior to the unit being installed. To do this, connect the negative wire (black wire) to the battery next to the motor on top of the unit.

The charger must be plugged into 115 VAC grounded outlet, and left plugged in all the time for the batteries to properly charge. The Owners Manual has a page that describes the lights that show on the charger.

CAUTION: Do not ride. Track brackets are not yet completely anchored.

INSTALLING THE LOWER LIMIT CAM

- 1 The upper and lower limit cams are safety devices that automatically stop the unit at each landing. They are on **opposite** sides of the track to hold the unit in place during shipping.
- 2 Locate the lower limit cam (on the track under the unit) and move to the bottom of the track - butting it against the bottom track cover and tighten into place.

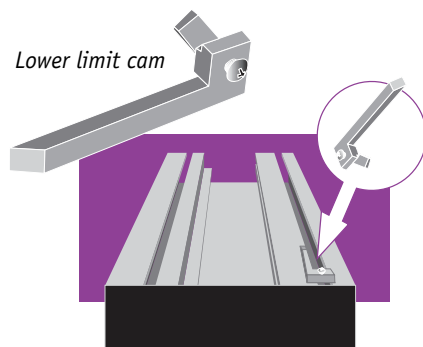

NOTE: Before the upper limit cam can be moved to its proper position, the seat will have to be attached to the unit chassis.

INSTALLING THE SEAT

- 1 Open the seat box and remove the seat and two call controls from the box. Set the call controls aside.

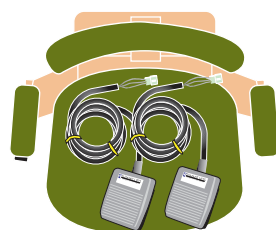

INSTALLING THE SEAT

- 3 Remove the four screws from the top of the unit. Set the screws/washers aside. **CAUTION:** Be careful not to drop screws/washers into unit while removing.
- 4 Set seat on top of unit chassis. Tip seat sideways and locate seat control wire. Plug into the unit seat control wire. Plugs can only go together one way.
- 5 Lower the seat to the unit chassis. Screw in place with four screws and lock washers previously set aside. Pull up on swivel arm to rotate the seat to gain access to all 4 holes.
- 6 If the seat is not level, then you will need to adjust the seat leveling.
- 7 There are 4 hex head screws that hold the seat level. There are two on the footrest side of the chassis, and two on the back side. Loosen all four a couple of turns (they cannot be taken out).
- 8 Firmly level the seat by pushing up on one arm and down on the other arm, until the seat is level.
- 9 Re-tighten the 4 hex head screws.

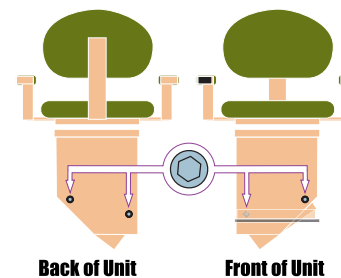
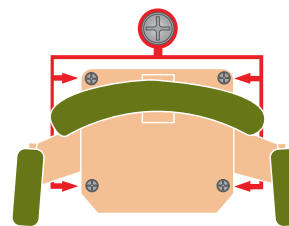
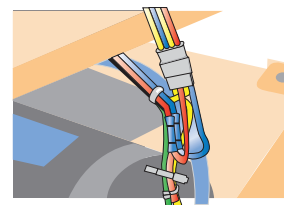
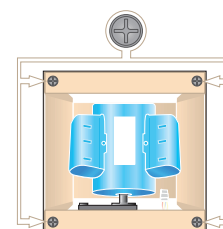

NOTE: While these screws are primarily used to adjust the level of the seat, they also serve to loosen the chassis so it realigns itself when needed.

NOTE: The unit is designed so it will not run unless the seat is facing forward and the swivel lock is in place.

INSTALLING THE UPPER LIMIT CAM

1. To install the upper limit cam, run the lift down about 1 foot by using the control on the armrest.
2. Locate the upper limit cam and move to the top of the track - position it approximately 1/2" from top track cover and tighten into place.
3. Final Limit Switch Actuator
In the event that the lift over travels or is moved up past the normal upper stop position, the lift will push the final limit actuator up into the final limit switch disabling the unit. In order to return the lift to operation, you must manually hand crank the lift down the track a few inches, and then slide the final limit actuator down approximately one inch by tapping on it.

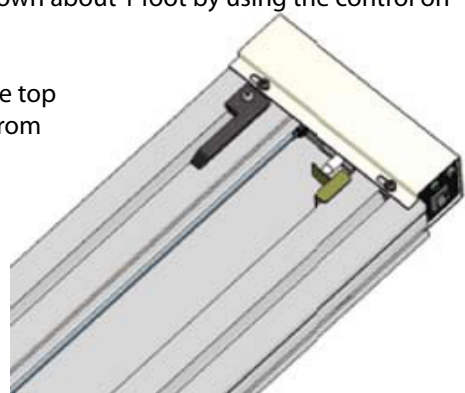

INSTALLING THE CALL CONTROLS

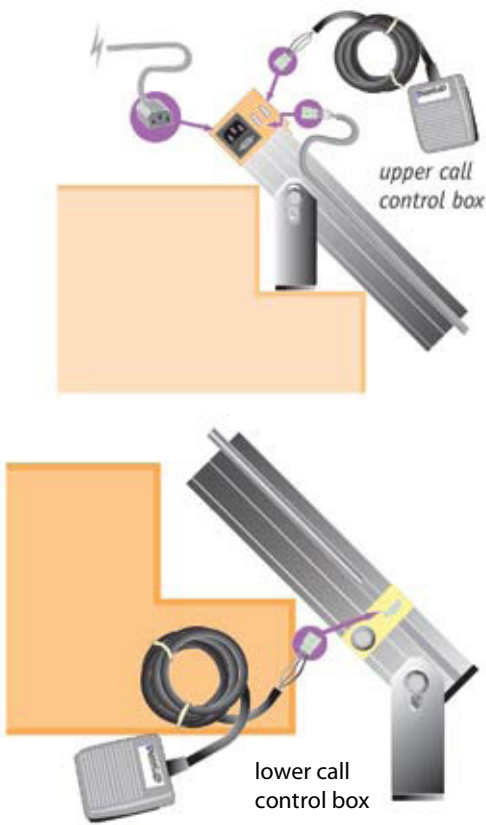

1. Finish routing the call control wire into the upper track channel on the wall side of the track. Plug into one of the two call control connectors.
 2. Plug in the upper call control box to a call control connector.
 3. Plug in the lower call control box to the call control connector at the bottom of the track.
 4. NOTE: Call controls can be mounted to the floor so they can be operated by your foot, or placed on the wall and operated by hand.
- Run the unit down to a few inches past the lowest track splice.

COMPLETING TRACK INSTALLATION

1. The unit should be parked in the middle of the track to evenly distribute its weight.
2. To complete the track installation, tighten each of the brackets - making sure they are tight to the stairs.
3. Press down on the track at each bracket and tighten the track bracket bolts to further anchor the track and minimize any flex in the track.

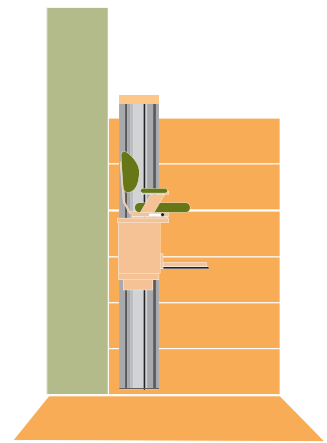

FINAL CHECKS



1. Read the Owner's Manual before riding the lift or allowing anyone else to ride the unit.
2. Test unit controls located on the chair arm - run unit a short distance down and up.
3. Test operation of upper and lower call controls.
4. Check footrest safety.
5. Warranty is in the owner's manual.
6. Start enjoying years of reliable service from your new stair lift.

ADDITIONAL NOTES

Have an installation question? Call 866-378-6648

